

VS 8-3

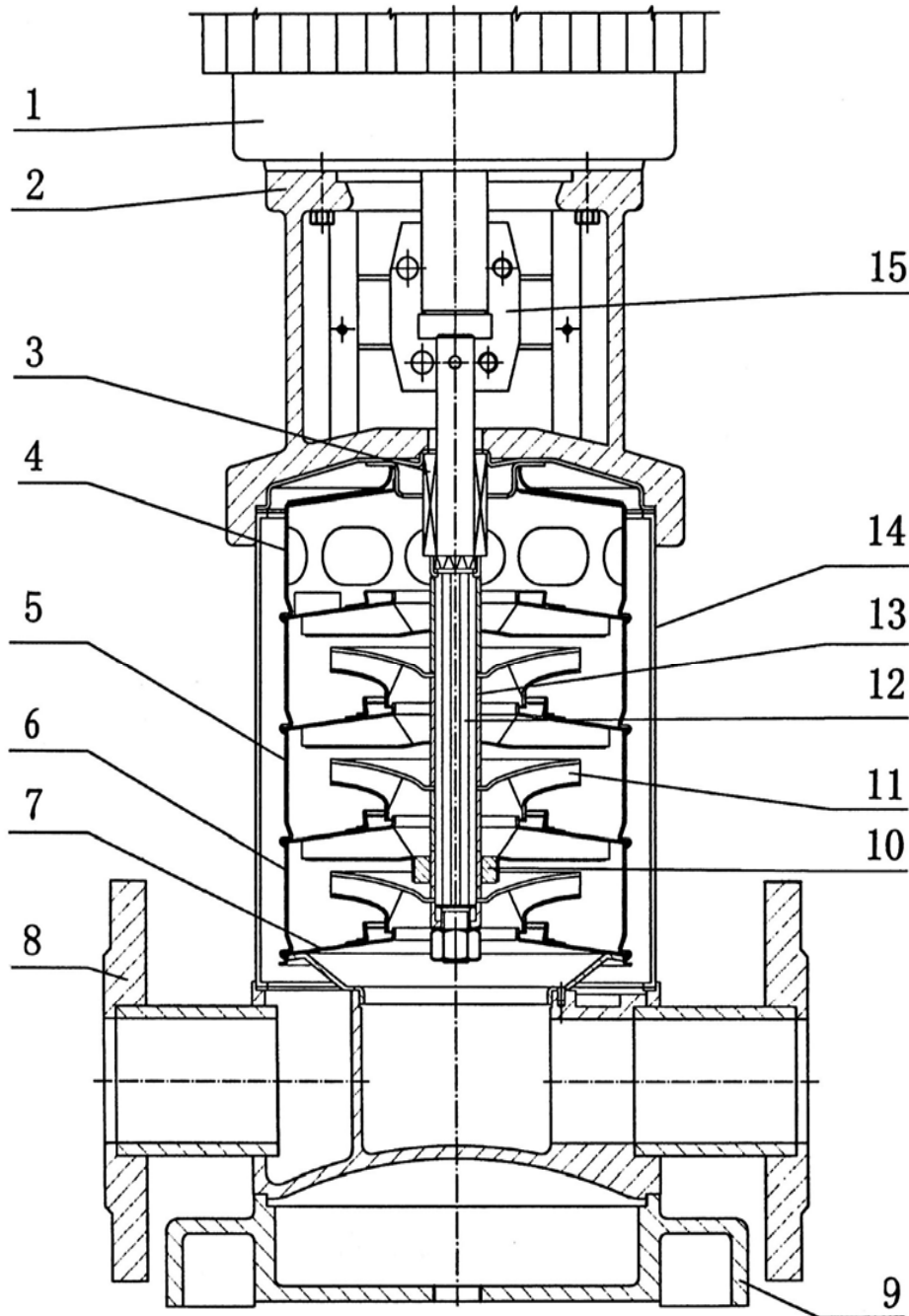

10/10/2007

KW 1,1



Pos.	Code	Description	
1	8101003	Electric motor Single phase	
1	8101019	Electric motor Three phase	
2	8101336	Pump head	
3	8101082	Mechanical seal	
4	8101101	Superior diffuser	
5	8101065	Diffuser	
6	8101091	Inferior diffuser	
7	8101372	Inducer	
8	8101382	Inlet and outlet section	
9	8101392	Base frame	
10	8101402	Bearing	
11	8101055	Impeller	
12	8101172	Shaft	
13	8101412	Impeller separating sleeve	
14	8101188	Cylinder	
15	8101292	Coupling	
	8101313	Counterflange	
	8101278	Rubber parts	
	8101440	Tie rods	