

NEW

PLUS SV

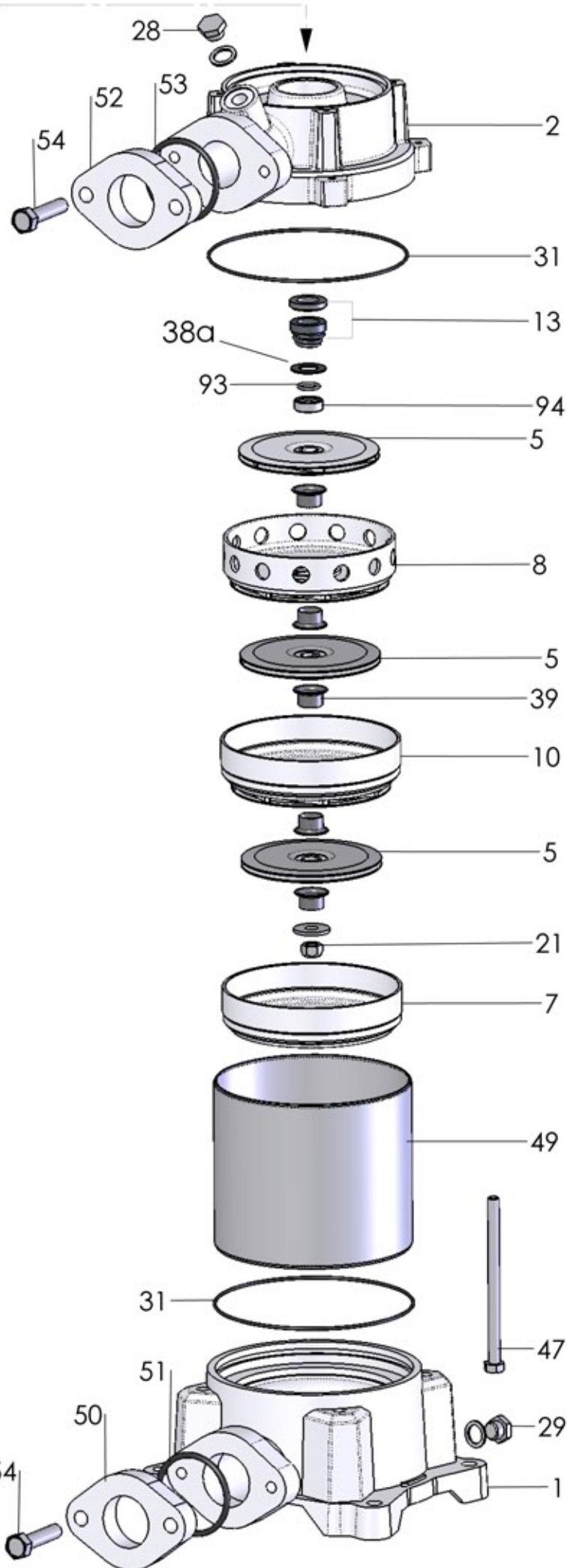
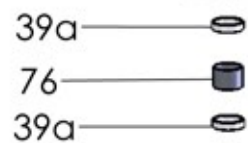
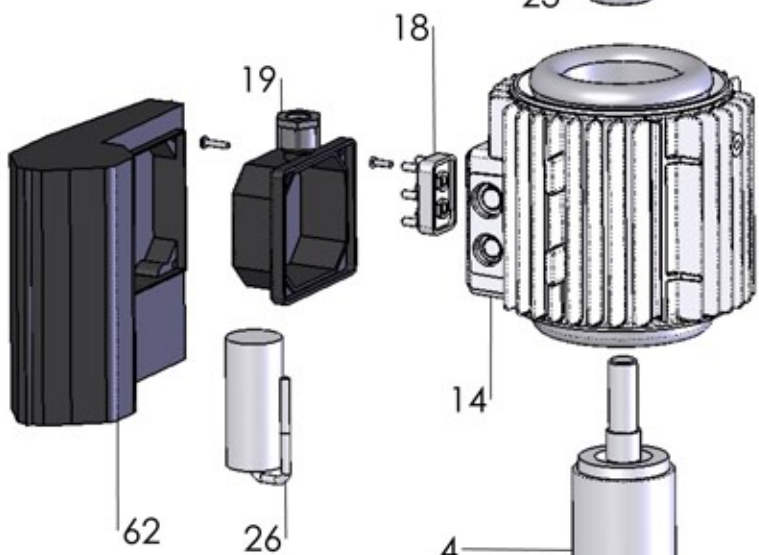
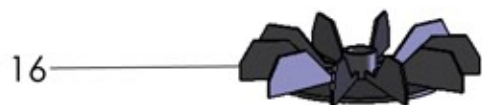
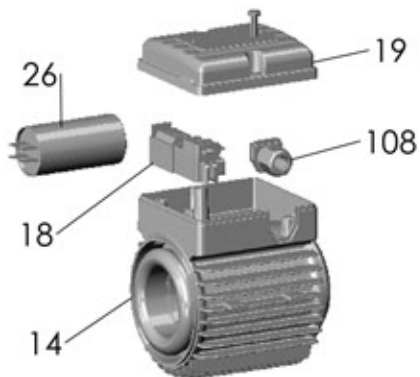

P 9SV 550/10 T

RIF	DESCRIZIONE	CODICE
1	corpo pompa	S70017056
2	supporto pompa motore	S70046049
4	albero con rotore trifase	S75405162A
5	girante in acciaio	M31427154
7	diffusore aspirante	M31419035
8	diffusore premente	M31419036
10	diffusore	M31419034
10a	diffusore con boccola	M31419037
13	tenuta meccanica	M60400047/8
14	cassa con statore trifase	S57900250
15	coperchio motore	S70214007
16	ventola	M60100004
17	copriventola	S71415003
18	morsettiera trifase	M61100004
19	coprimorsettiera	M62700006
20	paraspruzzi	M72606000
21	dado bloccaggio girante	M60513006
22	cuscinetto lato pompa	M60300008
23	cuscinetto lato ventola	M60300004
24	anello di compensazione	M60603003
25	tirante motore	M75450004
28	tappo di riempimento	M75147000
29	tappo di scarico	M75147000
31	anello O-R corpo pompa	M60900061
38a	rondella distanziale tenuta meccanica	M60600015
39	distanziale intermedio girante	M75118026
39a	distanziale giranti per diffusore con boccola	M75118031
47	tirante pompa	M75450054
49	tubo acciaio	M71401055
50	flangia bocca aspirazione	S70013009B
51	anello O-R bocca aspirazione	M60900044
52	flangia bocca mandata	S70013009A
53	anello O-R bocca mandata	M60900044
54	vite flangia	M60500148
76	bussola per diffusore	M75150012
93	semianello d'arresto	M60602011
94	rondella spallamento giranti	M60601012