

ECOSUB 420A

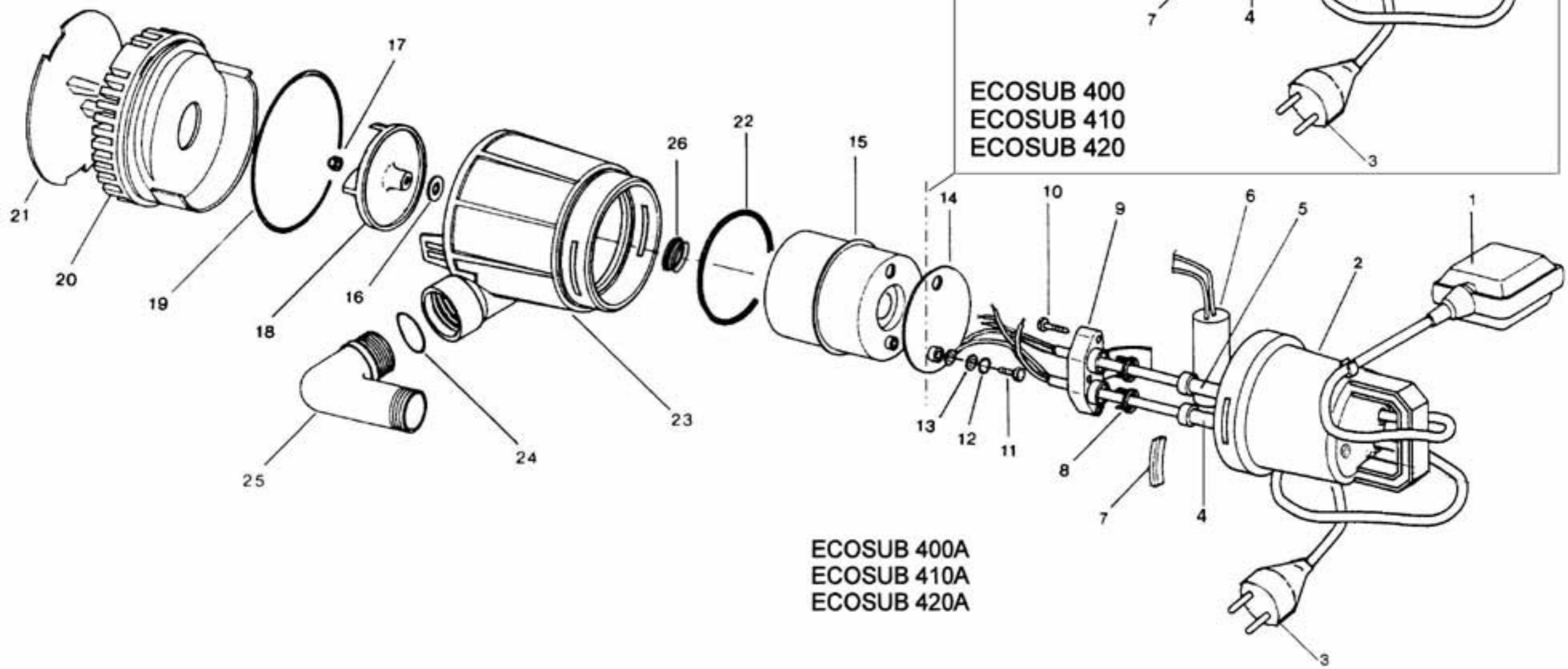
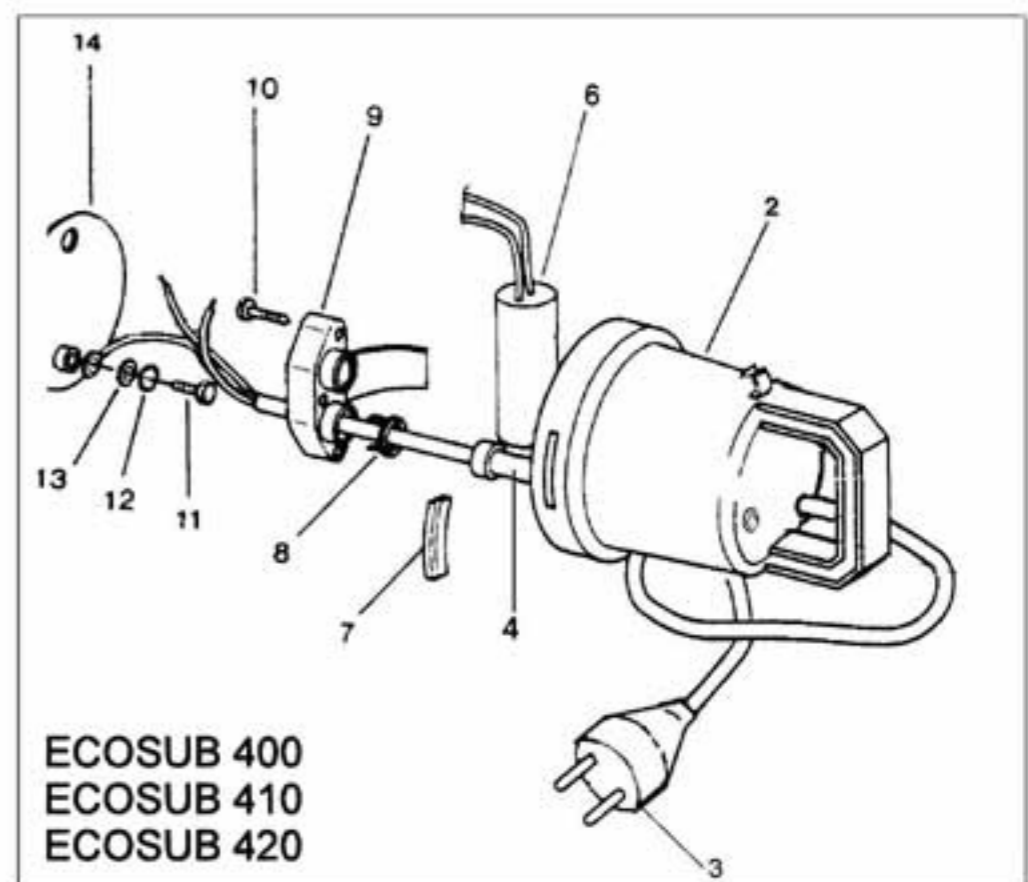

ECOSUB 420A

| Model | Ref. | Art. Leader | Descrizione | Description |
|-----------------------------------|------|-------------|--|-----------------------------------|
| ECOSUB 400-410-420-400A-410A-420A | 1 | P1380045 | Galleggiante (versione automatica) | Floatswitch (automatic version) |
| ECOSUB 400-410-420-400A-410A-420A | 2 | S3600169 | Coperchio 400 - 410 - 420 | Cap |
| ECOSUB 400-410-420-400A-410A-420A | 2 | S3600170 | Coperchio 400A-410A-420A (versione automatica) | Cap (automatic version) |
| ECOSUB 400-410-420-400A-410A-420A | 3 | P1320001 | Cavo di alimentazione 3m. H05RN-F | Cable 3m. H05RN-F |
| ECOSUB 400-410-420-400A-410A-420A | 3 | P1320025 | Cavo di alimentazione 10 m. H05RN-F | Cable 10m. H05RN-F |
| ECOSUB 400-410-420-400A-410A-420A | 3 | P1330004 | Cavo di alimentazione 10m. H07RN-F | Cable 10m. H07RN-F |
| ECOSUB 400-410-420-400A-410A-420A | 4 | P1230002 | Passacavo d7,1 | Grommet d7,1 |
| ECOSUB 400-410-420-400A-410A-420A | 4 | P1230003 | Passacavo d9 | Grommet d9 |
| ECOSUB 400-410-420-400A-410A-420A | 5 | P1230003 | Passacavo d9 (versione automatica) | Grommet d9 (automatic version) |
| ECOSUB 400-410-420-400A-410A-420A | 6 | P1360034 | Condensatore 410-410A-420-420A | Capacitor 410-410A-420-420A |
| ECOSUB 400-410-420-400A-410A-420A | 6 | P1360035 | Condensatore 400-400A | Capacitor 400-400A |
| ECOSUB 400-410-420-400A-410A-420A | 7 | S3500011 | Chiavetta | Lock |
| ECOSUB 400-410-420-400A-410A-420A | 8 | S3500336 | Anello antistrappo 400-410-420 | Anti-tear ring 400-410-420 |
| ECOSUB 400-410-420-400A-410A-420A | 8 | S3500336 | Anello antistrappo 400A-410A-420A | Anti-tear ring 400A-410A-420A |
| ECOSUB 400-410-420-400A-410A-420A | 9 | S3500335 | Clip pressacavo | Cable fastener |
| ECOSUB 400-410-420-400A-410A-420A | 10 | P1100008 | Vite | Screw |
| ECOSUB 400-410-420-400A-410A-420A | 11 | P1100003 | Vite terra | Earth screw |
| ECOSUB 400-410-420-400A-410A-420A | 12 | P1120003 | Rosetta elastica | Spring-washer |
| ECOSUB 400-410-420-400A-410A-420A | 13 | P1120051 | Rosetta | Washer |
| ECOSUB 400-410-420-400A-410A-420A | 14 | S3500106 | Disco isolante | Insulation disk |
| ECOSUB 400-410-420-400A-410A-420A | 15 | G4300001 | Gruppo motore 400-400A | Motor 400-400A |
| ECOSUB 400-410-420-400A-410A-420A | 15 | G4301001 | Gruppo motore 410-410A | Motor 410-410A |
| ECOSUB 400-410-420-400A-410A-420A | 15 | G4302002 | Gruppo motore 420-420A | Motor 420-420A |
| ECOSUB 400-410-420-400A-410A-420A | 16 | P1120008 | Rosetta | Washer |
| ECOSUB 400-410-420-400A-410A-420A | 17 | P1110005 | Dado | Nut |
| ECOSUB 400-410-420-400A-410A-420A | 18 | S3500528 | Girante 400-400A-410-410A | Impeller 400-400A-410-410A |
| ECOSUB 400-410-420-400A-410A-420A | 18 | S3500559 | Girante 420-420A | Impeller 420-420A |
| ECOSUB 400-410-420-400A-410A-420A | 19 | P1200008 | Guarnizione O.Ring | Joint O.Ring |
| ECOSUB 400-410-420-400A-410A-420A | 20 | S3500017 | Filtro | Filter |
| ECOSUB 400-410-420-400A-410A-420A | 21 | S3500107 | Base filtro | Filter base |
| ECOSUB 400-410-420-400A-410A-420A | 22 | P1200007 | Guarnizione O.Ring | Joint O.Ring |
| ECOSUB 400-410-420-400A-410A-420A | 23 | S3500015 | Corpo pompa 400-400A-410-410A | Pump housing 400-400A-410-410A |
| ECOSUB 400-410-420-400A-410A-420A | 23 | S3500016 | Corpo pompa 420-420A | Pump housing 420-420A |
| ECOSUB 400-410-420-400A-410A-420A | 24 | P1200009 | Guarnizione O.Ring | Joint O.Ring |
| ECOSUB 400-410-420-400A-410A-420A | 25 | S3600109 | Gomito 1.1/4"x27 400-400A-410-410A | Elbow 1.1/4"x27 400-400A-410-410A |
| ECOSUB 400-410-420-400A-410A-420A | 25 | S3600110 | Gomito 1.1/4"x35 420-420A | Elbow 1.1/4"x35 420-420A |
| ECOSUB 400-410-420-400A-410A-420A | 26 | P1210002 | Guarnizione V.Ring | V.Ring Joint |