

VS 2-11

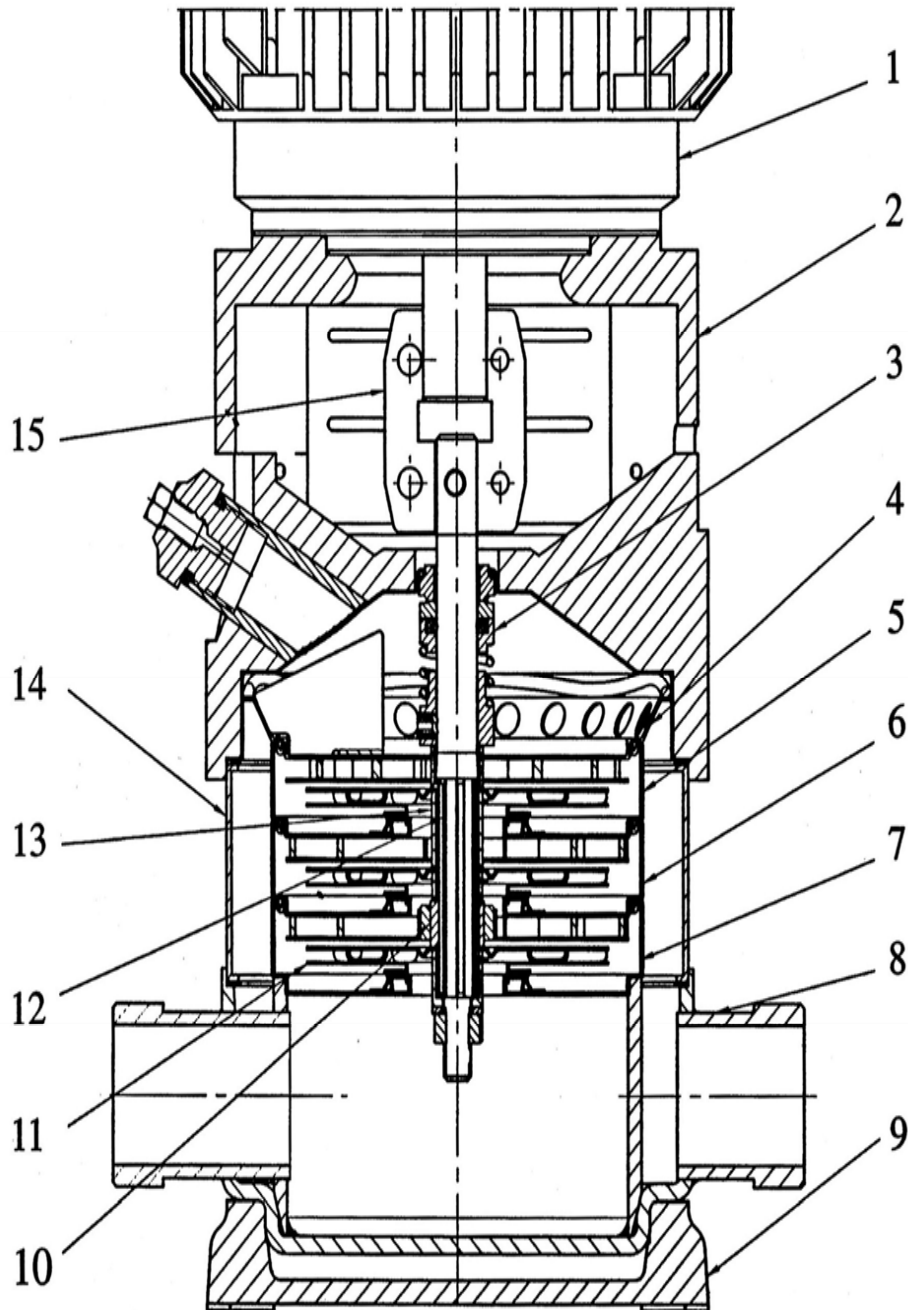

10/10/2007

KW 1,1



Pos.	Code	Description	
1	8101003	Electric motor Single phase	
1	8101019	Electric motor Three phase	
2	8101321	Pump head	
3	8101081	Mechanical seal	
4	8101098	Superior diffuser	
5	8101062	Diffuser	
6	8101088	Inferior diffuser	
7	8101370	Inducer	
8	8101380	Inlet and outlet section	
9	8101390	Base frame	
10	8101400	Bearing	
11	8101052	Impeller	
12	8101117	Shaft	
13	8101410	Impeller separating sleeve	
14	8101133	Cylinder	
15	8101290	Coupling	
	8101310	Counterflange	
	8101276	Rubber parts	
	8101422	Tie rods	