

NEW

PLUS SV

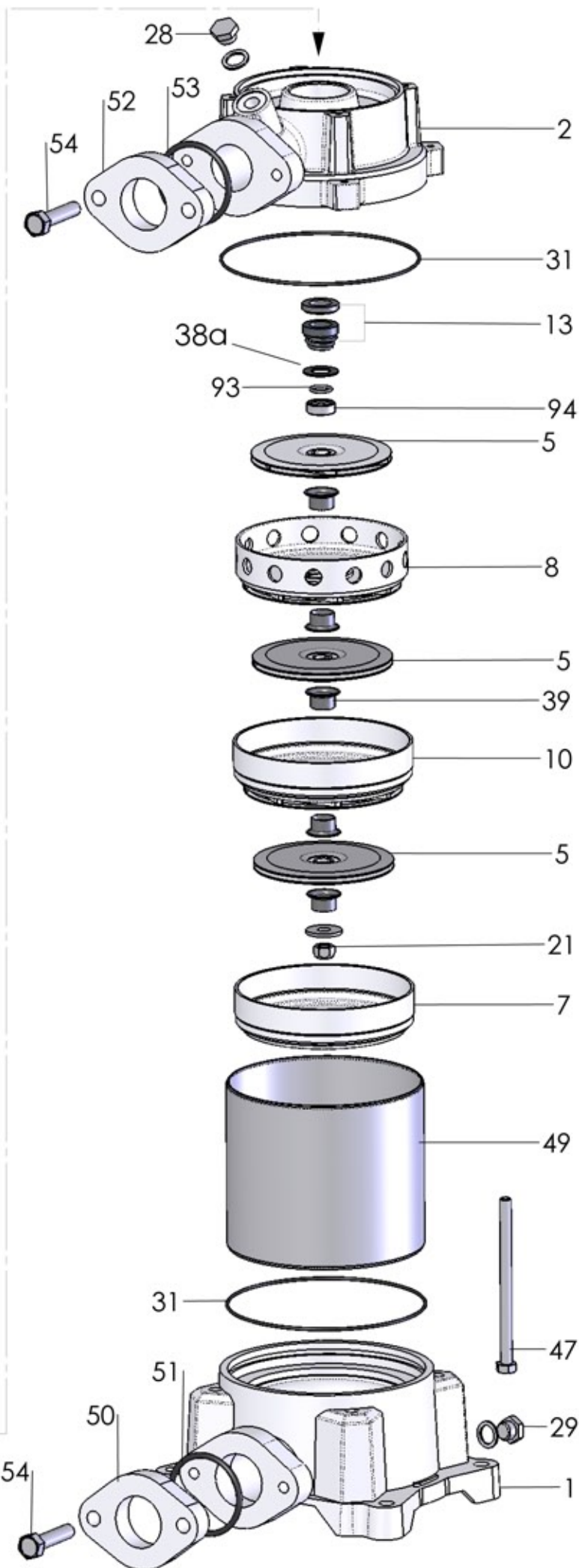
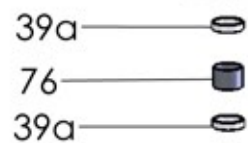
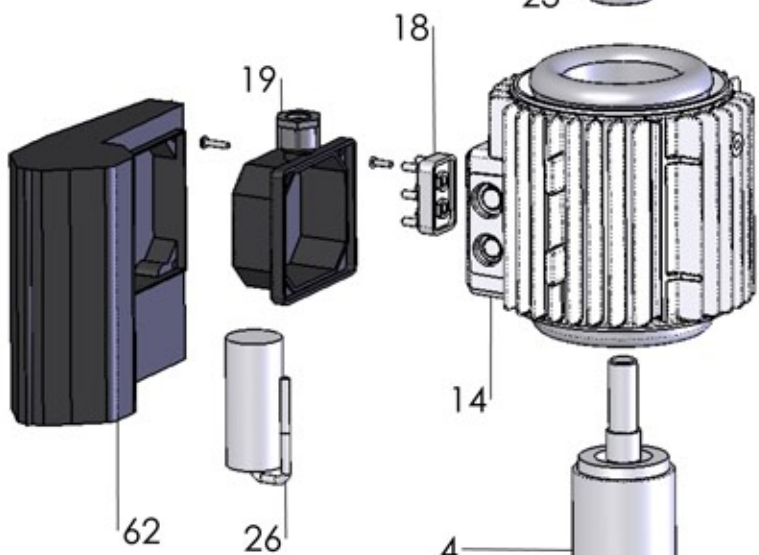
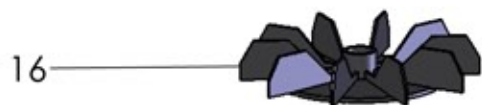
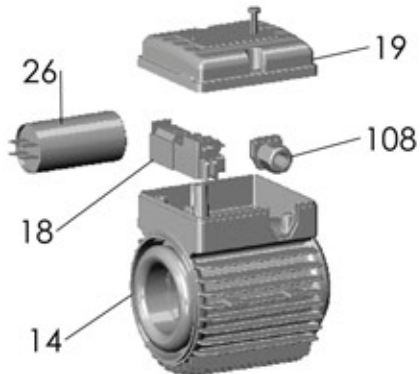

P 3SV 120/6

RIF	DESCRIZIONE	CODICE
1	corpo pompa	S70017056
2	supporto pompa motore	S70046046
4	albero con rotore monofase	S75405111A
4	albero con rotore trifase	S75405111A
5	girante in acciaio	M31427151
7	diffusore aspirante	M31419031
8	diffusore premente	M31419032
10	diffusore	M31419030
13	tenuta meccanica	M60400045/6
14	cassa con statore monofase	S57900098
14NEW	cassa con statore monofase	S57900098F
14	cassa con statore trifase	S57900175
14NEW	cassa con statore trifase	S57900175F
15	coperchio motore	S70214001
16	ventola	M60100002
17	copriventola	M60200021
18	morsettiera trifase	M61100001
18	morsettiera monofase	M61100007
18NEW	morsettiera monofase	M61101000
19	coprimorsettiera	M62700000
19NEW	coprimorsettiera	M62700036F
20	paraspruzzi	M72606003
21	dado bloccaggio girante	M60513006
22	cuscinetto lato pompa	M60300022
23	cuscinetto lato ventola	M60300001
24	anello di compensazione	M60603001
25	tirante motore	M75450002
26	condensatore 20 μ F - 450 V	M61400005
26NEW	condensatore 20 μ F - 450 V	M61400005F
28	tappo di riempimento	M75147000
29	tappo di scarico	M75147000
31	anello O-R corpo pompa	M60900061
39	distanziale intermedio girante	M75118025
47	tirante pompa	M75450047
49	tubo acciaio	M71401043
50	flangia bocca aspirazione	S70013009A
51	anello O-R bocca aspirazione	M60900044
52	flangia bocca mandata	S70013009A
53	anello O-R bocca mandata	M60900044

54	vite flangia	M60500148
62	scatola portacondensatore	M62700012F
93	semianello d'arresto	M60602011
94	rondella spallamento giranti	M60601011
108	pressacavo	M60701101